

SIRIUS *TTR*1

TABLETOP INTERNET RADIO

User Guide



SIRIUS  | **((XM))**
S A T E L L I T E R A D I O

Table of Contents

Introduction	5	Appendix: Manual Network Configuration	65
Features	6	Troubleshooting	75
Safety and Care Information	7	Product Specifications	81
What's in the Box?	9	Patent Information	83
SIRIUS TTR1 Radio Functions	10	Environmental Information	83
Remote Control	12		
Display Screen	13		
Installation	15		
Introduction	16		
Step 1: Connect to a Network	17		
Step 2: Enter Your SIRIUS Account Information	23		
Using Your SIRIUS TTR1 Radio	25		
Navigation Basics	26		
Direct Tune	30		
Favorite Channels	31		
Alarm Clock	32		
Snooze	34		
Sleep Timer	35		
Parental Control	36		
Equalization (EQ)	42		
Configuring Your SIRIUS TTR1 Radio	45		
SIRIUS setup	46		
System Setup	50		

Introduction

Features

Congratulations, on your purchase of the SIRIUS TTR1 Radio!

Your new SIRIUS TTR1 Radio comes with everything you need to enjoy SIRIUS Internet Radio in your home.

Use this manual to familiarize yourself with all of your SIRIUS TTR1 Radio features and capabilities. For the latest information about your SIRIUS TTR1 Radio and other SIRIUS products and accessories, visit <http://www.sirius.com>.

Please read the entire User Guide before using your SIRIUS TTR1 Radio!

Safety and Care Information



IMPORTANT! Always read and understand all the instructions to avoid injury to yourself and/or damage to your device. SIRIUS XM Radio Inc. disclaims all responsibility for damage from data loss due to breakdown, repair, or other causes.

- Do not expose to extreme temperatures (above 140°F or below -4°F, or above 60°C or below -20°C).
- Do not expose to moisture. Do not use device near or in water.
- Do not let any foreign matter spill into device.
- Do not store in dusty areas.
- Do not expose to chemicals such as benzene and thinners. Do not use liquid or aerosol cleaners. Clean with a soft damp cloth only.
- Do not expose to direct sunlight for a prolonged period of time, and do not expose to fire, flame, or other heat sources.
- Do not try to disassemble and/or repair device yourself.
- Do not drop your device or subject it to severe impact.
- Do not place heavy objects on device.
- Do not subject device to excessive pressure.
- If the screen is damaged, do not touch the liquid crystal fluid.

WARNING!

- Opening the case may result in electric shock.
- Make sure that you insert the plug all the way into the outlet.
- Do not touch the device with wet hands.

Introduction

- Do not install near any heat sources such as radiators, heat registers, stoves, or other apparatus (including amplifiers) that produce heat.
- Do not defeat the safety purpose of the polarized or grounding type plug. A polarized plug has two blades with one wider than the other. A grounding type plug has two blades and a third grounding prong. The wide blade or the third prong is provided for your safety. When the provided plug does not fit into your outlet, consult an electrician for replacement of the obsolete outlet.
- Protect the power cord from being walked on or pinched particularly at plugs, convenience receptacles, and the point where they exit from the apparatus.
- This product contains chemicals known to the State of California to cause cancer and birth defects or other reproductive harm.



When found on the apparatus, the lightning flash with arrowhead symbol indicates hazards arising from dangerous voltages.



When found on the apparatus, the exclamation point within an equilateral triangle symbol indicates the user should read all safety statements found in the user's manual.



When found on the apparatus, the double box symbol indicates double insulation.

WARNING

TO REDUCE THE RISK OF FIRE OR ELECTRIC SHOCK, DO NOT EXPOSE THIS APPARATUS TO RAIN OR MOISTURE.

What's in the Box?

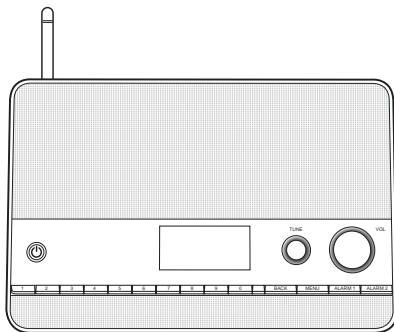

SIRIUS TTR1 Radio

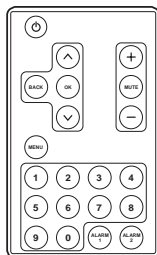

Remote Control

Introduction

SIRIUS TTR1 Radio Functions

Power Button (page 26)
Turn radio On and Off.

TUNE Knob (Multifunction) (page 26)
Turning the knob at the default display screen displays the category tune screen; pressing the knob at the default display screen displays the direct tune screen; turning the knob in a menu or user input screen scrolls through menus and choices; pressing the knob in a menu or user input screen selects a highlighted item; pressing and holding displays the **Parental control** menu.

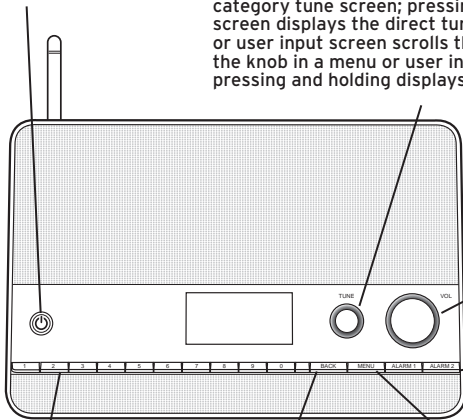

0-9 Number Buttons (page 26) Set and select channel presets or directly enter channel numbers.

BACK Button (page 27)
Press to return to the previous display screen.

MENU Button (page 27)
Press to access or exit category and channel tuning, advanced features, and configuration options.

VOL (Volume) Knob (page 26)
Increases or decreases volume; also mutes the audio.

ALARM 1 / ALARM 2 Buttons (page 27) Turns the alarm clocks On or Off; pressing and holding displays the alarm settings.

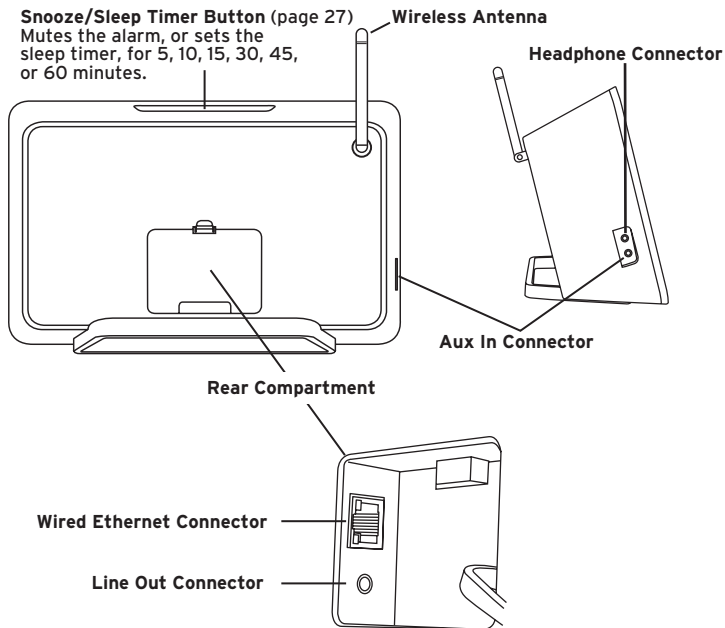

Introduction

Remote Control

Power Button

Turn radio On and Off.

OK Button

Press to select channel list and menu items.

BACK Button

Press to return back to the previous display screen.

MENU Button

Press to access or exit advanced features and configuration options.

0-9 Number Buttons

Set and select channel presets or directly enter channel numbers.

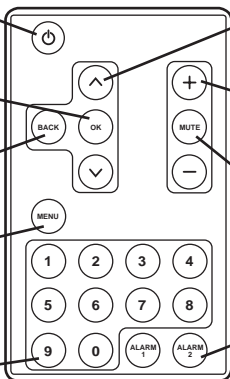

Arrow Buttons

Press to scroll through lists; also highlight menu options.

+/- Buttons

Press to increase or decrease the audio volume.

MUTE

Press to silence the audio.

ALARM 1 / ALARM 2

Press to turn the respective alarm clock On or Off; pressing and holding displays the alarm settings.

Display Screen

When using the SIRIUS TTR1 Radio, information about songs and artists, and radio functions are displayed.

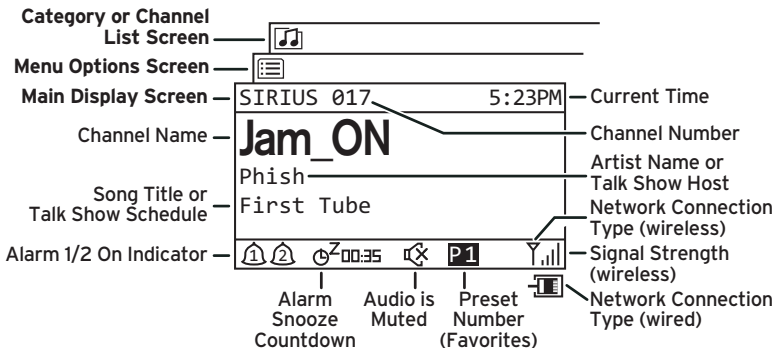

Installation

Introduction

The SIRIUS TTR1 Radio allows you to listen to all of the channels on your Premium SIRIUS Internet Radio subscription package using either a wireless Internet connection (Wi-Fi), or using a wired Ethernet connection.

You must be subscribed to the Premium SIRIUS Internet Radio service to use the SIRIUS TTR1 Radio. Go to www.sirius.com/siriusinternetradio or call 888-539-7474 to subscribe and get your user name and password. You can add this service to your SIRIUS subscription, or subscribe only to the Premium SIRIUS Internet Radio service.

To verify that you are subscribed to service, go to www.sirius.com, click on the **LISTEN ONLINE** link, and then click the **LAUNCH PLAYER** link. Enter your username and password. Select a channel to listen to and then click on the **PREMIUM** link. If you can listen in the Premium mode, then you are subscribed to the Premium SIRIUS Internet Radio service. Close the browser window to exit the player before continuing.

The SIRIUS TTR1 Radio supports a wireless Internet connection through any standard 802.11b/g access point. This includes wireless networks which are WEP/WPA/WPA2 protected and require a password, and wireless networks where the network name (SSID) is hidden. Once you have connected to a wireless network, the radio will remember your network settings so you will not have to enter the information again, unless you perform a reset of the radio to the factory defaults.

Step 1: Connect to a Network

The Network Wizard feature is the easiest way to connect to a wireless network. It searches for available wireless networks and displays a list of wireless networks found for you to select. However, if your wireless network name (SSID) is hidden, or if your network is DHCP disabled, you'll have to manually enter the network settings rather than using the Network Wizard.

Decide whether you will be using a wireless network connection, or a wired network connection, and whether you can use the Network Wizard or if you'll need to manually configure your network settings. Complete the instructions in the appropriate section:

Connect to a WIRELESS network using the NETWORK WIZARD (page 17)

Connect to a WIRED network using the NETWORK WIZARD (page 21)

Connect to a WIRELESS network using MANUAL settings (page 66)

Connect to a WIRED network using MANUAL settings (page 71)

Installation

To connect to a wireless network using the Network Wizard

If the wireless network is secured, you'll need to enter the key (password) for the wireless network during the connection procedure. If you don't know the password, contact your network administrator or the person who setup the wireless network.

- a. If you have just turned your SIRIUS TTR1 Radio on for the first time, the **SSID** screen will already be displayed. Skip ahead to step e.
- b. Press **MENU** and turn the **TUNE knob** to highlight **System Setup**. Press the **TUNE Knob**.
- c. Turn the **TUNE knob** to highlight **Network**. Press the **TUNE Knob**.
- d. Press the **TUNE Knob** to select **Network Wizard**.
- e. The radio will scan for wireless networks and return with a list of wireless networks which were found. (A sample screen is shown here. Your actual wireless network name will appear in the list, if found.) Turn the **TUNE knob** to highlight your wireless network and press the **TUNE knob**. If you don't know the network name, contact your network administrator or the person who set up the wireless network.
- f. If you choose an unsecured network, and the radio is able to connect to the wireless network, the **Connected** screen will be

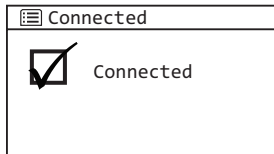
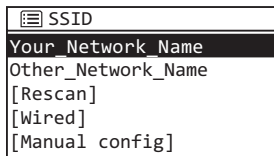

displayed and the radio will connect to the wireless network. Skip to step **h**.

If you choose a network that is secured, you will be prompted to enter the key (password). If you don't know the password, contact your network administrator of the person who setup the wireless

network. Remember that the key is case sensitive. Turn the **TUNE knob** to scroll through the list of characters and highlight each character. Press the **TUNE knob** to select the highlighted character and move to the next character. If you make a mistake, turn the **TUNE knob** to highlight **BKSP** and press the **TUNE knob** to erase the character.

- g.** When the key has been entered, turn the **TUNE knob** to scroll to highlight **OK** and press the **TUNE knob**. If you have entered the correct key, and the radio is able to connect to your wireless network, the **Connected** screen will be displayed. If you have entered the wrong key, the **Incorrect key** screen is displayed, and you will be prompted to enter the key again.
- h.** If you are installing your SIRIUS TTR1 Radio for the first time, continue with "Step 2: Enter Your SIRIUS Account Information" on page 23.

☰ Key:	
█	
123456789., ab	BKSP
cdefghijklmnopq	OK
rstuvwxyzABCDEF	CANCEL
GHIJKLMNOPQRSTU	



Installation

If you have previously entered your SIRIUS user name and key into the radio, and had tuned to a channel, the screen will show **Connecting**. When successfully connected, the **Buffering...** screen will be displayed as the channel information is streamed to the radio. When complete, you are returned to the main display screen and you should hear the audio playing. Otherwise, the **Category Tune** screen is displayed.

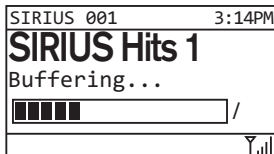
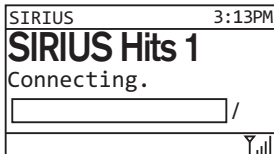

To connect to a wired network using the Network Wizard:

- a. At the rear of the radio, remove the compartment cover and connect an Ethernet cable to the Ethernet connector on the inside left of the compartment. Refer to “Wired Ethernet Connector” on page 11 for the location of the Ethernet connector. Replace the compartment cover.
- b. Connect the other end of the Ethernet cable to your home's wired network.
- c. If you have turned your SIRIUS TTR1 Radio on for the first time, the SSID screen will already be displayed. Skip ahead to step g.
- d. Press **MENU** and turn the **TUNE knob** to highlight **System Setup**. Press the **TUNE Knob**.
- e. Turn the **TUNE knob** to highlight **Network**. Press the **TUNE Knob**.
- f. Press the **TUNE Knob** to select **Network Wizard**.
- g. The radio will scan for networks. When the scan is complete, turn the **TUNE knob** to highlight **[Wired]** and press the **TUNE knob**.
- h. If the radio is able to connect to your network, the **Connected** screen will be displayed. If **Waiting for Ethernet**

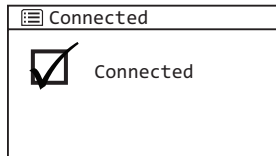
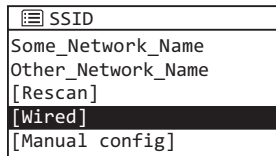

Installation

is displayed, check the Ethernet cable connections.

- i. If you are installing your SIRIUS TTR1 Radio for the first time, continue with “Step 2: Enter Your SIRIUS Account Information” on page 23.

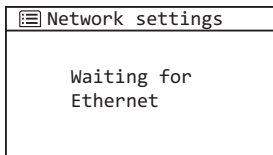

If you have previously entered your SIRIUS user name and key into the radio, and had tuned to a channel, the screen will show **Connecting**. When successfully connected, the **Buffering...** screen will be displayed as the channel information is streamed to the radio. When complete, you are returned to the main display screen and you should hear the audio playing. Otherwise, the **Category Tune** screen is displayed.

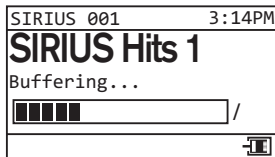
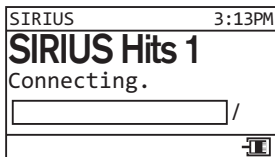

Step 2: Enter Your SIRIUS Account Information

The SIRIUS TTR1 Radio needs your account user name and password to connect to SIRIUS Internet Radio service. If are not yet subscribed to the SIRIUS Internet Radio service, go to www.sirius.com/siriusinternetradio or call 888-539-7474 to subscribe, and get your user name and password.

To enter your account information:

- a. Turn on the radio by pressing the **Power button**.
- b. Press **MENU** and turn the **TUNE knob** to highlight **SIRIUS Setup**. Press the **TUNE knob**.
- c. Turn the **TUNE knob** to highlight **User name**. Press the **TUNE knob**.
- d. Turn the **TUNE knob** to scroll through the list of characters and highlight each character for your user name. Press the **TUNE knob** to select the highlighted character and move to the next character. If you make a mistake, turn the **TUNE knob** to highlight **BKSP** and press the **TUNE knob** to erase the character.
- e. When you have entered your user name, turn the **TUNE knob** to

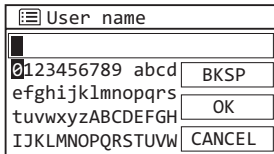
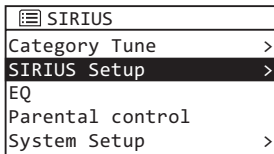

Installation

scroll to highlight **OK** and press the **TUNE knob**.

- f. You will then be prompted to enter your password. Enter your password in the same way as you entered your user name and then select **OK**. Note that the password is case sensitive.
- g. The radio will attempt to connect to the SIRIUS Internet Radio service. If the user name and password you entered is incorrect, the **Login failed** screen will be displayed. You'll have to re-enter the correct user name and password.

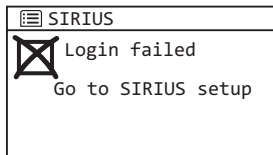

If you have previously connected to a network, and had tuned to a channel, the screen will show **Connecting**. When successfully connected, the **Buffering...** screen will be displayed as the channel information is streamed to the radio. When complete, you are returned to the main display screen and you should hear the audio playing. Otherwise, the **Category Tune** screen is displayed.

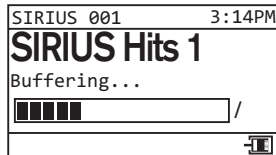
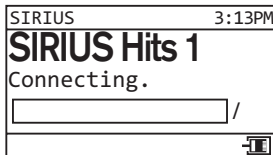

Using Your SIRIUS TTR1 Radio

Using Your SIRIUS TTR1 Radio

Navigation Basics

Power Button

The **Power button** turns the SIRIUS TTR1 Radio On or Off.



Tune Knob

The **TUNE knob** is multifunction– you can turn it clockwise or counter-clockwise, and press it.



- **Turn:** Turning the **TUNE knob** when at the main display screen displays the **Category tune** screen. When in menus or user input screens, turning the **TUNE knob** scrolls up or down through menus and user choices.
- **Press and Release:** Pressing the **TUNE knob** at the default display screen displays the **Direct tune** screen. When in menus or user input screens, pressing the **TUNE knob** selects a highlighted item.
- **Press and Hold:** pressing and holding the **TUNE knob** displays the **Parental control** menu options.

VOL Knob

Turning the **VOL knob** clockwise or counter-clockwise increases or decreases the volume of the audio. When turned counter-clockwise it will mute the audio when zero is reached.



Number Buttons 0-9



The number buttons are used to store favorite channels in a button location so you can tune a channel just by pressing the button. They can also be used to enter the channel number when at the **Direct tune** screen.

BACK Button



The **BACK** button returns back to the previously displayed screen.

MENU Button



Pressing the **MENU** button from the main display screen accesses the advanced features and configuration options menu, where you can browse the channel categories and channels, and change the radio settings. Pressing it when in the configuration options menu returns the radio to the main display screen.

ALARM 1 / ALARM 2 Buttons



Pressing the **ALARM** button turns the respective alarm clock function On or Off. Pressing and holding the **ALARM** button displays the respective alarm setup screen where you can configure the options for each alarm.

Snooze / Sleep Button

When the alarm clock is sounding, pressing the **Snooze/Sleep** button will silence the alarm for 5 minutes. Each additional immediate press of the **Snooze/Sleep** button increases the snooze time for 10, 15, 30, 45 or 60 minutes. While snoozing, the snooze countdown time is displayed on the display screen.

While the radio is playing, pressing the **Snooze/Sleep** button enters the sleep mode. The first press displays **Sleep OFF**, and each immediate additional press sets the sleep time for 5, 10, 15, 30, 45 or 60 minutes.

While in snooze or sleep mode, the countdown time is displayed on the display screen. You can also check and change the remaining snooze/sleep time by pressing the **Snooze/Sleep** button. To increase the sleep or snooze time, repeatedly press the **Snooze/Sleep** button until the desired sleep/snooze time is displayed.

Using Your SIRIUS TTR1 Radio

Listening to SIRIUS Internet Radio

Tune a Channel:

1. Press **MENU**.
2. Press the **TUNE knob** to select **Category Tune**.
3. Press the **TUNE knob** to select **All Channels** to browse through all the channels, or turn the **TUNE knob** to highlight a category. Press the **TUNE knob** to select the category.
4. Turn the **TUNE knob** browse through the channels, and highlight a channel to tune. Press the **TUNE knob** to tune the channel. The radio will momentarily tune the channel.

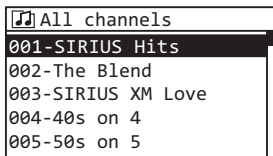

TIP! Go to www.sirius.com/internetradio and click on the **View Channel Lineup** link to view more information about the SIRIUS Internet Radio channel programming.

View a Category:

Channels are organized into categories to make it easier for you to find the ones that suit your taste.

1. To view the categories press **MENU**.

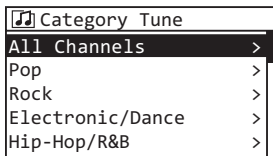

2. Press the **TUNE knob** to select **Category Tune**.
3. Turn the **TUNE knob** to browse through and highlight a category.
4. Press the **TUNE knob** to select the category and view the channels in the category.

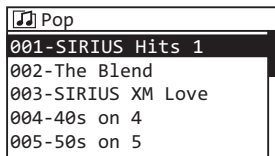

Returning to Main Display Screen

When in the advanced features and configuration options menu, pressing **MENU** will return you to the main display screen.

Using Your SIRIUS TTR1 Radio

Direct Tune

A channel can be tuned directly by entering the channel number.

1. From the main display screen, press the **TUNE button**.
2. Use the **0-9** number buttons on the radio or Remote Control to enter the channel number. If you make a mistake, turn the **TUNE knob** to highlight **BKSP** and press the **TUNE knob** erase the character.
3. When the channel number is entered, turn the **TUNE knob** to highlight **OK**. Press the **TUNE knob** to tune the channel.

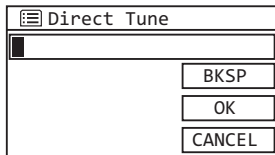

Favorite Channels

You can assign up to 10 of your favorite channels to a number button (0-9) so you can easily tune them.

To assign a favorite channel to a number button:

1. Tune to the channel you want as a favorite.
2. Press and hold a number button (**0-9**) for one second to assign the channel as a favorite (preset) to that button.



IMPORTANT! If the button you choose already has a favorite channel assigned to it, it will be replaced with the new favorite channel.

To tune a favorite channel:

1. Press the number button **0-9** that is assigned to the favorite channel. The channel will momentarily be tuned.

Using Your SIRIUS TTR1 Radio



Alarm Clock

Your SIRIUS TTR1 Radio has two alarm clocks which can be configured according to your liking. When the radio is off, and the alarm(s) are on, the times of each alarm are displayed on the screen.

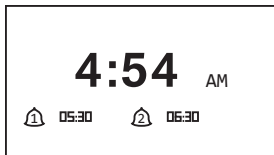
Before you configure the alarm clock, refer to “Clock Setup” on page 53 and ensure that the Time Zone and Daylight Savings Time are set correctly.



To turn the alarm clocks On or Off:

1. Press the **ALARM 1** or **ALARM 2** button to toggle the alarms On or Off. If the alarm(s) are On, the alarm icon(s)   will be displayed in the lower left of the main display screen.

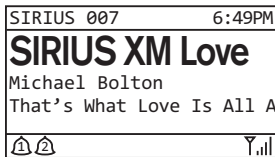

To configure an alarm clock:

1. Press **MENU**. You can also press and hold the alarm button that you want to configure to go directly to the alarm configuration (go to step 4).
2. Turn the **TUNE knob** to scroll to and highlight **System Setup**. Press the **TUNE knob**.
3. Turn the **TUNE knob** to scroll to and highlight **Alarms**. Press the **TUNE knob**.

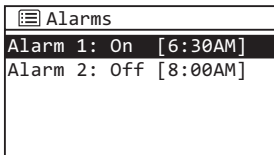

- The Alarms screen summarizes each alarm clock setting. To configure an alarm, turn the **TUNE knob** to scroll to and highlight **Alarm 1** or **Alarm 2**. Press the **TUNE knob**.
- Each alarm has 5 configuration options which are summarized in the following table at the beginning of this section. To change an option, turn the **TUNE knob** to scroll to and highlight the option. Press the **TUNE knob** to configure the option.

☰ Alarm 1
Enable: Daily
Time: 6:30AM
Wake to: SIRIUS
Preset: Last Listened
Volume: 5

Enable	Off Daily Once Weekends Weekdays
Time	12:00 AM - 11:59 PM
Wake to	SIRIUS Buzzer
Preset	Last listened (last channel tuned) Any favorite channel (1 - 10)
Volume	1 - 20

- Turn the **TUNE knob** to scroll to and highlight a setting for each option. Press the **TUNE knob** to select the setting. Continue until you have configured all the options for the alarm.
- When you are done, press **Alarm 1** or **Alarm 2** to save the alarm setting.



Alarm
Saved

Using Your SIRIUS TTR1 Radio

Snooze

When the alarm sounds, pressing the **Sleep/Snooze** button will silence the alarm for a period of time. After the snooze time elapses, the alarm will sound again.

To snooze:

1. Press the **Snooze/Sleep** button on the top of the radio. The radio will display a snooze time of **05 minutes**.
2. Each immediate subsequent press of the **Snooze/Sleep** button increases the snooze time to 10, 15, 30, 45, or 60 minutes.
3. For the snoozing alarm, a countdown timer is displayed showing how many minutes are remaining before the alarm sounds again. The alarm icon will also blink for the snoozing alarm.
4. You can also check and change the remaining snooze time by pressing the **Snooze/Sleep** button. To increase the snooze time, repeatedly press the **Snooze/Sleep** button until the desired snooze time is displayed.

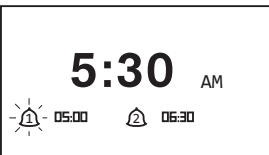
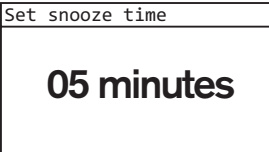

Sleep Timer

The sleep timer turns the radio off after a period of time as you fall asleep. The time can be set to turn the radio off after 5, 10, 15, 30, 45, or 60 minutes.

To turn the sleep timer On:

1. Press the **Snooze/Sleep** button on the top of the radio. The radio will display a sleep time of **05 minutes**.
2. Each subsequent press of the **Snooze/Sleep** button increases the sleep time to 10, 15, 30, 45, or 60 minutes.
3. A countdown timer is displayed at the bottom of the screen showing how many minutes are remaining before the radio turns off.
4. You can also check and change the remaining sleep time by pressing the **Snooze/Sleep** button. To increase the sleep time, repeatedly press the **Snooze/Sleep** button until the desired sleep time is displayed.

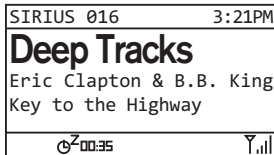
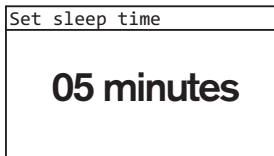

To turn the sleep timer Off:

1. Repeatedly press the **Snooze/Sleep** button on the top of the radio until **Off** is displayed.



Using Your SIRIUS TTR1 Radio

Parental Control

Your SIRIUS TTR1 Radio has a parental control feature which will allow you to lock access to channels. A 4-digit code controls access to the locked channel or locked category.

When you browse a category, the locked channel will have an L displayed to the right of the channel name.

If you attempt to tune to a locked channel, either by using direct tune or through the category list, you'll be prompted to enter your 4-digit code. When the correct code is entered, you'll be able to tune to the channel.

All locked channels become unlocked and will remain unlocked until you turn the radio Off, and back On.

If the radio is turned off while listening to a locked channel, the next time you turn the radio on, you will be prompted to enter your lock code. If you cancel, and do not enter your lock code, the channel will display Parental locked.

To change the parental lock code:

The SIRIUS TTR1 Radio has a default lock code of **1111**. The first time you change the lock code, you'll need to enter this code during the procedure.

1. Press **MENU**. You can also press and hold the **TUNE knob** to go directly to parental control (go to step 3).
2. Turn the **TUNE knob** to scroll to and highlight **Parental control**. Press the **TUNE knob**.

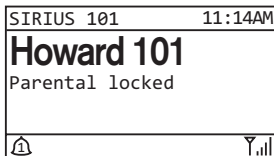
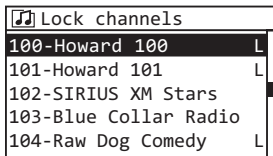

3. Turn the **TUNE knob** to highlight **Change lock code**. Press the **TUNE knob**.
4. You will be prompted to enter the original lock code. If this is the first time you are changing the lock code, enter 1111, otherwise enter your existing lock code. Use the **0-9** number buttons on the radio or Remote Control to enter the lock code. If you make a mistake, turn the **TUNE knob** to highlight **BKSP** and press the **TUNE knob** to erase the character. When you have selected all 4 digits of your code, turn the **TUNE knob** to highlight **OK** and press the **TUNE knob**.

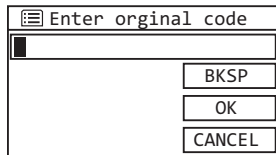

5. You will be prompted to enter the new code. Enter the new code you desire in the same way. When you have selected all 4 digits of your code, turn the **TUNE knob** to highlight **OK** and press the **TUNE knob**.
6. You will be prompted to enter the new code again. Enter the new code again in the same way. When you have selected all 4 digits of your code, turn the **TUNE knob** to highlight **OK** and press the **TUNE knob**.
7. If you have entered code correctly, **New** will be displayed.

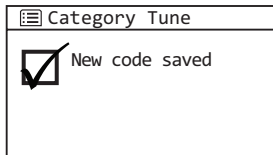

TUNE knob
press the
your new
Code Saved

Using Your SIRIUS TTR1 Radio

8. Press **MENU** to exit.

To turn Parental control Off:

1. Press and hold the **TUNE knob**.
2. **Lock/Unlock** will be highlighted. Press the **TUNE knob**.
3. You will be prompted to enter your 4-digit lock code. Use the **0-9** number buttons on the radio or Remote Control to enter the lock code. If you make a mistake, turn the **TUNE knob** to highlight **BKSP** and press the **TUNE knob** to erase the character. When you have selected all 4 digits of your code, turn the **TUNE knob** to highlight **OK** and press the **TUNE knob**.

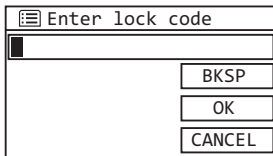

4. If you have entered the correct code, the parental lock is turned off. If you entered an incorrect code, **Parental lock code mismatch** message will be displayed, and the channels will remain locked.

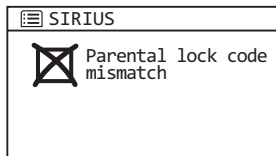
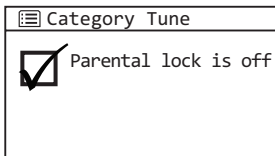

To lock or unlock channels:

1. Press and hold the **TUNE knob**.
2. Turn the **TUNE knob** to scroll through the list and highlight **Lock channels**. Press the **TUNE knob**.
3. If parental control is On (locked), you will be prompted to enter your 4-digit code, otherwise skip to step 4. Use the **0-9** number buttons on the radio or Remote Control to enter the lock code. If you make a mistake, turn the **TUNE knob** to highlight **BKSP** and press the **TUNE knob** to erase the character. When you have selected all 4 digits of your code, turn the **TUNE knob** to highlight **OK** and press the **TUNE knob**.

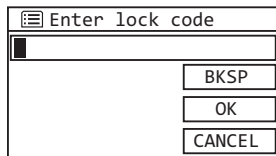

4. When you have successfully unlocked parental control, a list of all the channels will be displayed. Turn the **TUNE knob** to scroll through the list and highlight a channel that you wish to lock. Press the **TUNE knob** to lock the channel. An **L** will be displayed to the right of the channel name indicating that the channel is locked.

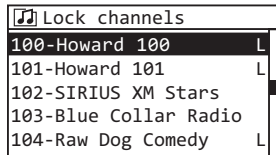

Using Your SIRIUS TTR1 Radio

To unlock a channel, highlight a locked channel and press the **TUNE knob**. The **L** lock indicator will be removed indicating that the channel is unlocked.

- Continue to lock or unlock channels until you are done. When complete, press **MENU**. You will be prompted to save the parental lock list. Turn the **TUNE knob** to highlight **YES** and press the **TUNE knob**.
- A confirmation screen will be displayed. Press **MENU** to exit.

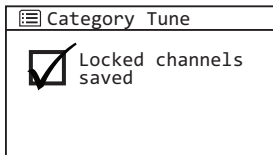
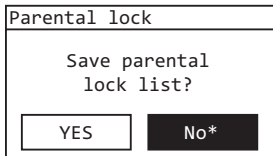

To listen to a locked channel:

When you tune to a locked channel, the channel will display **Parental locked** and no audio will play until you have unlocked the channel.

- Select the locked channel which will display **Parental locked**.
- Press the **TUNE knob**.
- Use the **0-9** number buttons on the radio or Remote Control to enter the lock code. If you make a mistake, turn the **TUNE knob** to highlight **BKSP** and press the **TUNE**

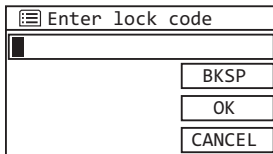

knob to erase the character. When you have selected all 4 digits of your code, turn the **TUNE knob** to highlight **OK** and press the **TUNE knob**.

4. If you have entered the correct lock code, the channel will begin playing.

Once you have unlocked one channel, all locked channels become unlocked and will remain unlocked until you turn the radio Off. The next time you turn the radio On, all channels will be locked.

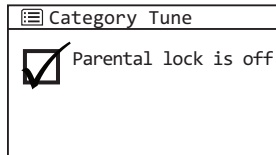

Using Your SIRIUS TTR1 Radio

Equalization (EQ)

You can adjust the equalization profile of the radio to adjust for room acoustics and your listening pleasure. The profiles for equalization are Flat, Loudness, Bass Boost, Bright, and Vocal Boost.

Another adjustment option is spatialization. Spatialization makes the radio sound like it is in a three-dimensional environment. By default, spatialization is on, but can be turned off.

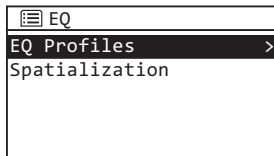

To change the equalization profile:

1. Press **MENU**.
2. Turn the **TUNE knob** to scroll to and highlight **EQ**. Press the **TUNE knob**.
3. Press the **TUNE knob** to select **EQ Profiles**.
4. The currently selected profile will be denoted with an asterisk. Turn the **TUNE knob** to scroll to and highlight the equalization profile desired, and press the **TUNE knob**. The radio will change to the new equalization profile.
5. Press **MENU** to exit.

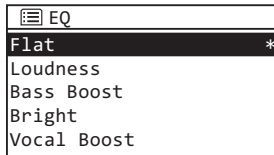

To turn spatialization on or off:

- 1.** Press **MENU**.
- 2.** Turn the **TUNE knob** to scroll to and highlight **EQ**. Press the **TUNE knob**.
- 3.** Turn the **TUNE knob** to scroll to and highlight **Spatialization**. Press the **TUNE knob**.
- 4.** Turn the **TUNE knob** to highlight **ON** or **OFF** and press the **TUNE knob**.
- 5.** Press **MENU** to exit.

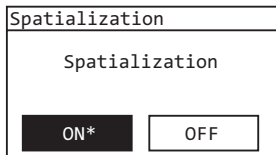

Configuring Your SIRIUS TTR1 Radio

Configuring Your SIRIUS TTR1 Radio

SIRIUS setup

The **SIRIUS setup** menu option allows you to configure your user name and password for the SIRIUS Internet Radio service. You can also check the status of your connection.

If are not yet subscribed to the SIRIUS Internet Radio service, go to www.sirius.com/siriusinternetradio or call 888-539-7474 to subscribe, and get your user name and password.

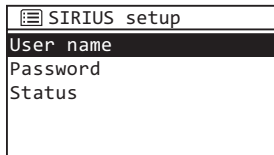

To test whether you are subscribed to service, go to www.sirius.com, click on the **LISTEN ONLINE** link, and then click the **LAUNCH PLAYER** link. Enter your username and password. Select a channel to listen to and then click on the **PREMIUM** link. If you can listen in the Premium mode, then you are subscribed to the SIRIUS Internet Radio service. Close the browser window to exit the player before continuing.

User name and Password

This option allows you to enter your user name and password for the SIRIUS Internet Radio service. If for any reason your user name or password should change after you had entered the information into the radio, use these procedures to re-enter your user name and password.

To enter your user name:

1. Press **MENU**.

- Turn the **TUNE knob** to scroll to and highlight **SIRIUS setup**. Press the **TUNE knob**.
- User name** will be highlighted. Press the **TUNE knob**.
- Turn the **TUNE knob** to scroll through the list of characters and highlight each character for your user name. Press the **TUNE knob** to select the highlighted character and move to the next character. If you make a mistake, turn the **TUNE knob** to highlight **BKSP** and press the **TUNE knob** erase the character.
- When you have entered your user name, turn the **TUNE knob** to scroll to highlight **OK** and press the **TUNE knob**.
- You'll now be prompted to enter your password. Continue with the step 4 in next section, and enter your password.

☰ User name	
█	
0123456789 abcd	BKSP
efghijklmnopqrs	OK
tuvwxyzABCDEFGH	CANCEL
IJKLMNOPQRSTUVWXYZ	

To enter your password:

- Press **MENU**.
- Turn the **TUNE knob** to scroll to and highlight **SIRIUS setup**. Press the **TUNE knob**.
- Turn the **TUNE knob** to scroll to and highlight **Password**. Press the **TUNE knob**.

Configuring Your SIRIUS TTR1 Radio

4. Turn the **TUNE knob** to scroll through the list of characters and highlight each character for your password. The password is case sensitive. Press the **TUNE knob** to select the highlighted character and move to the next character. If you make a mistake, turn the **TUNE knob** to highlight **BKSP** and press the **TUNE knob** erase the character.

Password	
█	
0123456789 abcd	BKSP
efghijklmnopqrs	OK
tuvwxyzABCDEFGH	
IJKLMNOPQRSTUVWXYZ	CANCEL

5. When you have entered your user name, turn the **TUNE knob** to scroll to highlight **OK** and press the **TUNE knob**.
6. The Saved screen will be displayed. If you have correctly entered the information, the radio will display the **Connecting...** and then the **Loading...** screens. If your user name or password is incorrect, the **Login failed** screen will be displayed.

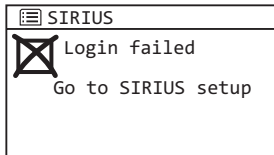
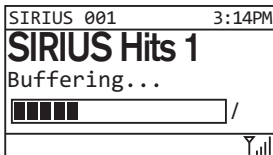

Status

The **Status** screen shows the current status of your Premium SIRIUS Internet Radio service, the user name you are using, and the bit rate of your connection.

To display the status:

1. Press **MENU**.
2. Turn the **TUNE knob** to scroll to and highlight **SIRIUS setup**. Press the **TUNE knob**.
3. Turn the **TUNE knob** to scroll to and highlight **Status**. Press the **TUNE knob**.
4. The Status screen will be displayed. Press **MENU** to exit.

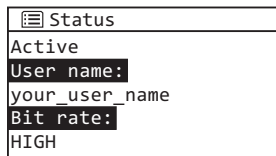

Configuring Your SIRIUS TTR1 Radio

System Setup

The System Setup menu option offers the following menu items:

SIRIUS	page 51
AUX in	page 51
Alarms	page 52
Alarm 1:	page 52
Alarm 2:	page 52
Brightness	page 52
Clock Setup	page 53
Set Time/Date	page 53
Auto Update	page 54
Time Zone	page 54
Daylight savings	page 55
Network	page 56
Network wizard	page 56
View Settings	page 57
Manual Settings	page 58
Network profile	page 58
Factory reset	page 60
Software update	page 61
Auto-check setting	page 61
Check now	page 62
Info	page 64

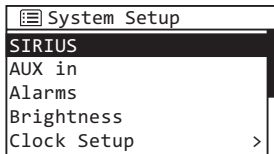

Refer to the sections following for each menu option.

SIRIUS and AUX in

These two menu options select what the radio will play— **SIRIUS** selects the SIRIUS Internet Radio service to be played, and **AUX in** selects the auxiliary input to be played. You can connect a CD or MP3 player to the **AUX In** connector, and listen to it.

To select auxiliary in to be played:

1. Press **MENU**.
2. Turn the **TUNE knob** to scroll to and highlight **System Setup**. Press the **TUNE knob**.
3. Turn the **TUNE knob** to scroll to and highlight **AUX in**. Press the **TUNE knob**.
4. The **Auxiliary input** screen will be displayed, and the radio will play the input from the **AUX In** connector.

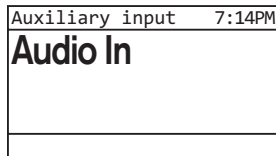

To switch from AUX in to SIRIUS:

1. Press **MENU**.
2. Turn the **TUNE knob** to scroll to and highlight **System Setup**. Press the **TUNE knob**.
3. **SIRIUS** will be highlighted. Press the **TUNE knob**.
4. The radio will switch back to SIRIUS and connect to the SIRIUS Internet Radio service.

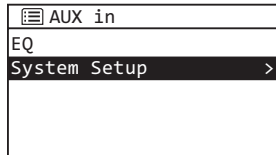

Configuring Your SIRIUS TTR1 Radio

Alarms

Before setting any alarms, refer to “Clock Setup” on page 53 and ensure that the clock is set correctly, i.e., the Time Zone and Daylight Savings Time are set correctly for your location. Then refer to “Alarm Clock” on page 32 for information about the alarm clocks. Refer to “Snooze” on page 34 for more information about the snooze function.

Brightness

Brightness has four settings to set the brightness of the display screen, Automatic, High, Medium, and Low. The **Automatic** setting adjusts the brightness of the display screen according to the background light in the room, automatically dimming the display screen the darker the room.

To change the display screen brightness:

1. Press **MENU**.
2. Turn the **TUNE knob** to scroll to and highlight **System Setup**. Press the **TUNE knob**.
3. Turn the **TUNE knob** to scroll to and highlight **Brightness**. Press the **TUNE knob**.
4. Turn the **TUNE knob** to display your desired setting, Automatic, High, Medium, or Low. Press the **TUNE knob** to select your setting.
5. Press **MENU** to exit.



Clock Setup

Clock Setup allows you to change the clock settings:

- **Set Time/Date** - Change the time and/or date.
- **Auto Update** - Synchronize the clock via the Internet Yes or No. **Yes** is the default and preferred setting. The radio will automatically update the time, keeping it accurate.
- **Time Zone** - Select the time zone you are in.
- **Daylight savings** - Turn daylight savings time On or Off.

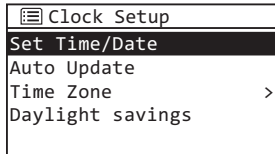

To set the time and date:

1. Press **MENU**.
2. Turn the **TUNE knob** to scroll to and highlight **System Setup**. Press the **TUNE knob**.
3. Turn the **TUNE knob** to scroll to and highlight **Clock Setup**. Press the **TUNE knob**.
4. **Set Time/Date** will be highlighted. Press the **TUNE knob**.
5. Turn the **TUNE knob** to select the desired hour, and press the **TUNE knob** to advance to the next field. Continue doing this until

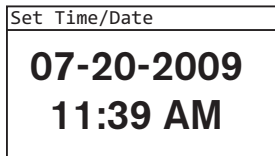

Configuring Your SIRIUS TTR1 Radio

you have finished.

To set Auto Update:

1. Press **MENU**.
2. Turn the **TUNE knob** to scroll to and highlight **System Setup**. Press the **TUNE knob**.
3. Turn the **TUNE knob** to scroll to and highlight **Clock Setup**. Press the **TUNE knob**.
4. Turn the **TUNE knob** to scroll to and highlight **Auto Update**. Press the **TUNE knob**.
5. Turn the **TUNE knob** to select either **YES** or **NO**, and press the **TUNE knob**.
6. Press **MENU** to exit.

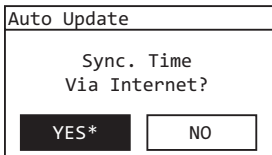

To set your time zone:

1. Press **MENU**.
2. Turn the **TUNE knob** to scroll to and highlight **System Setup**. Press the **TUNE knob**.
3. Turn the **TUNE knob** to scroll to and highlight **Clock Setup**. Press the **TUNE knob**.

- Turn the **TUNE knob** to scroll to and highlight **Time Zone**. Press the **TUNE knob**.
- Turn the **TUNE knob** to scroll to and highlight the time zone you are in. Press the **TUNE knob**.
- Press **MENU** to exit.

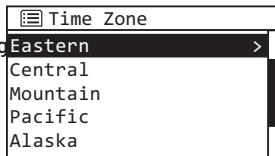

To set daylight savings time:

- Press **MENU**.
- Turn the **TUNE knob** to scroll to and highlight **System Setup**. Press the **TUNE knob**.
- Turn the **TUNE knob** to scroll to and highlight **Clock Setup**. Press the **TUNE knob**.
- Turn the **TUNE knob** to scroll to and highlight **Daylight savings**. Press the **TUNE knob**.
- Turn the **TUNE knob** to select either **ON** or **OFF**, and press the **TUNE knob**.
- Press **MENU** to exit.



Configuring Your SIRIUS TTR1 Radio

Network

Network allows you to view and change the network settings:

- **Network wizard** - Helps you to easily connect to a network
- **View settings** - Displays information about your network connection
- **Manual Settings** - Allows you to manually setup your connection to a network
- **Network profile** - Displays the wireless network connections saved in the radio

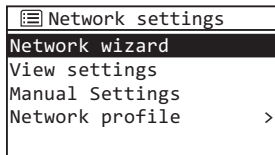

Each **Network** menu option is discussed in the sections which follow.

Network Wizard:



IMPORTANT! To connect to a wireless network which restricts access by MAC address, the MAC address of the SIRIUS TTR1 Radio must be added to the allowed list of MAC addresses in the access point before connecting. You can find the MAC address of your radio by pressing **MENU**, then turning and pressing the **TUNE knob** to highlight and select: **System Setup** → **Network** → **View settings**. The MAC address of the SIRIUS TTR1 Radio will be displayed.

Refer to one the following sections for detailed instructions on using the **Network Wizard** to connect to a network:

- For connecting to a wireless network, refer to “To connect to a wireless network using the Network Wizard” on page 18.
- For connecting to a wired network, refer to “To connect to a wired network using the Network Wizard:” on page 21.

View settings:

View Settings displays information about your network connection, including the type of connection, the status, the radio’s MAC address, and other network connection details such as IP addresses.

To view the network settings:

1. Press **MENU**.
2. Turn the **TUNE knob** to scroll to and highlight **System Setup**. Press the **TUNE knob**.
3. Turn the **TUNE knob** to scroll to and highlight **Network**. Press the **TUNE knob**.
4. Turn the **TUNE knob** to scroll to and highlight **View settings**. Press the **TUNE knob**.
5. Turn the **TUNE knob** to scroll through the network settings.
6. Press **MENU** to exit.

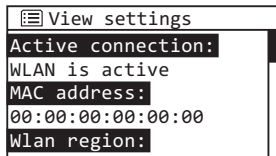

Configuring Your SIRIUS TTR1 Radio

Manual Settings:

Refer to one the following sections for detailed instructions on using the **Manual Settings** to connect to a network:

- For connecting to a wireless network, refer to “Connect to a Wireless Network Using Manual Settings” on page 66.
- For connecting to a wired network, refer to “Connect to a Wired Network Using Manual Settings” on page 71.

Network profile:

Network profile displays the wireless network connections which are stored in the radio when you connect to a wireless network. The currently active profile is denoted with a “*”. You can delete the profiles if desired.

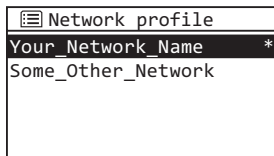

To view and delete the network profiles:

Note that you cannot delete the active wireless network profile.

1. Press **MENU**.
2. Turn the **TUNE knob** to scroll to and highlight **System Setup**. Press the **TUNE knob**.

3. Turn the **TUNE knob** to scroll to and highlight **Network**. Press the **TUNE knob**.
4. Turn the **TUNE knob** to scroll to and highlight **Network profile**. Press the **TUNE knob**.
5. The saved wireless network names will be displayed. If you wish to delete a profile, turn the **TUNE knob** to scroll to and highlight a profile name. Press the **TUNE knob**.
6. Confirm that you really want to delete the profile. Turn the **TUNE knob** to highlight YES or NO and press the **TUNE knob**.
7. Press **MENU** to exit.

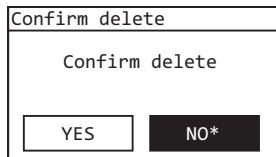

Configuring Your SIRIUS TTR1 Radio

Factory reset

Factory reset restores the SIRIUS TTR1 Radio to the factory settings. It will erase all the stored network settings, account user name and password, favorite channels, alarm clock settings, lock code, and set all other options back to the factory settings.

To restore the radio to the factory settings:

1. Press **MENU**.
2. Turn the **TUNE knob** to scroll to and highlight **System Setup**. Press the **TUNE knob**.
3. Turn the **TUNE knob** to scroll to and highlight **Factory reset**. Press the **TUNE knob**.
4. Confirm that you really want to proceed with the factory reset. Turn the **TUNE knob** to highlight YES or NO and press the **TUNE knob**.
5. The screen will display Restarting and the radio turn off.

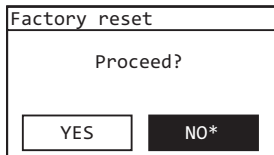

Software update

Software update allows you to set the radio to automatically check for any available software updates, and also to manually force the radio to check if an update is available. SIRIUS occasionally updates the software for their radios. Check www.sirius.com for any updated documentation associated with a software update.

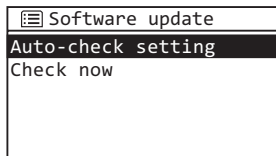

By default, the SIRIUS TTR1 Radio is set to automatically check for updates. If it finds a software update, you'll be prompted that a new software is available. You can change this setting so the radio will not automatically check for updates.

To change automatic software updates:

1. Press **MENU**.
2. Turn the **TUNE knob** to scroll to and highlight **System Setup**. Press the **TUNE knob**.
3. Turn the **TUNE knob** to scroll to and highlight **Software Update**. Press the **TUNE knob**.
4. Turn the **TUNE knob** to scroll to and highlight **Auto-check setting**. Press the **TUNE knob**.
5. Select whether you periodically

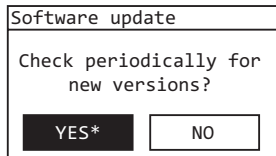

Configuring Your SIRIUS TTR1 Radio

want the radio to check for software updates. Turn the **TUNE knob** to highlight YES or NO and press the **TUNE knob**.

6. Press **MENU** to exit.

To force the radio to check for a software update:

1. Press **MENU**.
2. Turn the **TUNE knob** to scroll to and highlight **System Setup**. Press the **TUNE knob**.
3. Turn the **TUNE knob** to scroll to and highlight **Software Update**. Press the **TUNE knob**.
4. Turn the **TUNE knob** to scroll to and highlight **Check now**. Press the **TUNE knob**.
5. The radio will check for a software update. If an update is available, the radio will download and install the update. If no update is available, **Software up to date** will be displayed. If a software update is available, **Software update** is displayed.
6. Press **MENU** to exit.

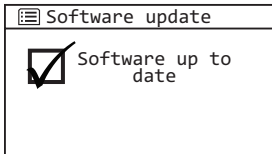
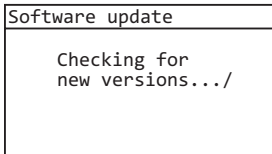

Updating the software:

If you manually force the radio to check for a software update, or the radio automatically finds a software update, and you want to update the software, follow these steps.

1. The **Software update** screen is displayed. Turn the **TUNE knob** to highlight **YES** and press the **TUNE knob**.
2. The radio will download the software update. Allow the download to finish.
3. When the download is complete, you will be prompted to proceed with the installation of the software. The default answer is **YES**. Press the **TUNE knob** to proceed.
4. You will be warned not to power off the radio, and the radio will be updated with the new software.

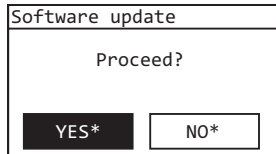
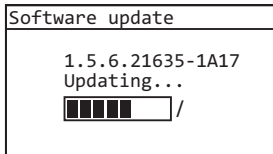
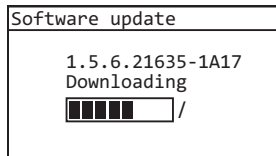
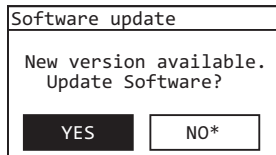

Configuring Your SIRIUS TTR1 Radio

5. When the update is complete, you'll be prompted to **Press OK/Tune to start**. Press the **TUNE knob**.
6. The radio will start with the new software.

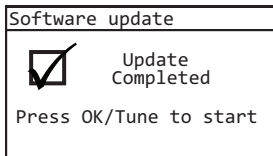

Info

Info displays the software version number, and the Radio ID number.

To display the information:

1. Press **MENU**.
2. Turn the **TUNE knob** to scroll to and highlight **System Setup**. Press the **TUNE knob**.
3. Turn the **TUNE knob** to scroll to and highlight **Info**. Press the **TUNE knob**.
4. The software version number, and the Radio ID number will be displayed.
5. Press **MENU** to exit.

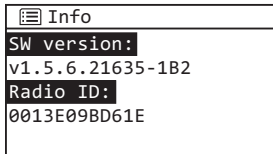

Appendix: Manual Network Configuration

Connecting to a network using the **Manual settings** requires some knowledge of your network. You'll need to manually configure your network connection using the **Manual Settings** or **[Manual config]** option if your wireless network name (SSID) is hidden, or if your network is DHCP disabled.

Decide whether you will be using a wireless network connection (page 66), or a wired Ethernet connection (page 71). Then follow the instructions in the appropriate following section.

Connect to a Wireless Network Using Manual Settings

In order to connect to a wireless network, you will need to have the following information to enter during the procedure:

Is DHCP enabled or disabled?	
If disabled, the IP address to use for the radio?	
If disabled, the Subnet Mask?	
If disabled, the Gateway IP address?	
If disabled, the Primary DNS IP address?	
If disabled, the Secondary IP address?	
The name of your wireless network (SSID)?	
Is the wireless network password protected?	
If so, the type of authentication?	
If Pre-Shared Key, whether WEP is enabled?	
If WPA or WPA2, whether it's TKIP or AES?	
The wireless network key (password)?	

- a. If you have just turned your SIRIUS TTR1 Radio on for the first time, the SSID screen will already be displayed. Skip ahead to step d.
- b. Press **MENU** and turn the **TUNE knob** to highlight **System Setup**. Press the **TUNE Knob**.
- c. Turn the **TUNE knob** to highlight **Network**. Press the **TUNE Knob**.
- d. Turn the **TUNE Knob** to highlight **Manual Settings** or [**Manual config**]. Press the **TUNE Knob**.

- e. Turn the **TUNE Knob** to highlight **Wireless**. Press the **TUNE Knob**.
- f. Will you be using DHCP? Turn the **TUNE Knob** to highlight **DHCP enable** or **DHCP disable** and press the **TUNE Knob**.

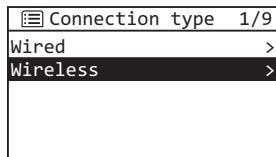

- g. If you have selected **DHCP disable**, enter the following information. Otherwise, continue with step h.

For each entry, Turn the **TUNE knob** to select the numbers, and press the **TUNE knob** to confirm and move to the next number. Press **BACK** if you entered an incorrect number.



TIP! You can use the Remote Control to increment the numbers (∧ ∨), and move forward or backward through the number fields (+ and -).

- i. Enter the IP address to use for the radio.
- ii. Enter the Subnet Mask for the network.

Appendix: Manual Network Configuration

- iii. Enter the Gateway IP address for the network.
- iv. Enter the Primary DNS IP address for the network.
- v. Enter the Secondary DNS IP address for the network, or leave blank if there is none.

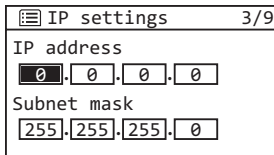

IP settings 3/9

IP address
0 . 0 . 0 . 0

Subnet mask
255 . 255 . 255 . 0

- h. Enter your wireless network name (SSID). Note that the SSID is case sensitive. Turn the **TUNE knob** to scroll through the list of characters and highlight each character. Press the **TUNE knob** to select the highlighted character and move to the next character. If you make a mistake, turn the **TUNE knob** to highlight **BKSP** and press the **TUNE knob** to erase the character. When done, turn the **TUNE knob** to highlight **OK** and press the **TUNE knob**.

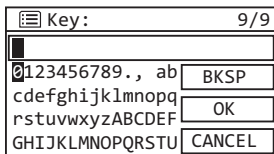

Key: 9/9

123456789., ab BKSP
cdefghijklmnopq OK
rstuvwxyzABCDEF
GHIJKLMNOPQRSTU CANCEL

- i. Select the authentication type, Open (no key (password)), Pre-Shared Key, WPA, or WPA2. Turn the **TUNE Knob** to highlight your selection and press the **TUNE knob**. If you have selected Open, skip ahead to step k.

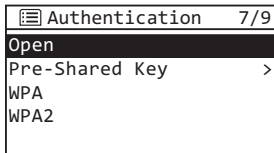

Authentication 7/9

Open

Pre-Shared Key >

WPA

WPA2

- j. Depending upon your selection, complete these additional steps:

- **Pre-Shared Key:**

- i. Select whether the Pre-Shared Key has WEP encryption disabled or

disabled. Turn the **TUNE Knob** to highlight your selection and press the **TUNE knob**.

- ii. Enter your key (password). Turn the **TUNE knob** to scroll through the list of characters and highlight each character. Press the **TUNE knob** to select the highlighted character and move to the next character. If you make a mistake, turn the **TUNE knob** to highlight **BKSP** and press the **TUNE knob** erase the character.

• **WPA or WPA2:**

- i. Select whether WPA or WPA2 has TKIP or AES encryption. Turn the **TUNE Knob** to highlight your selection and press the **TUNE knob**.
- ii. Enter your key (password). Remember that the key is case sensitive. Turn the **TUNE knob** to scroll through the list of characters and highlight each character. Press the **TUNE knob** to select the highlighted character and move to the next character. If you make a mistake, turn the **TUNE knob** to highlight **BKSP** and press the **TUNE knob** to erase the character. When done, turn the **TUNE knob** to highlight **OK** and press the **TUNE knob**.

- k. If you have entered the correct information, and the radio is able

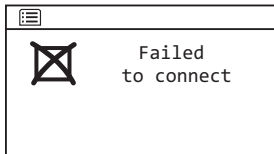
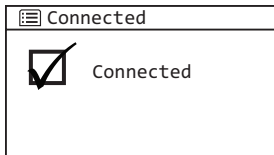

Appendix: Manual Network Configuration

to connect to your wireless network, the **Connected** screen will be displayed. If not, the **Failed to connect** screen is displayed. This means that one or more of the settings you entered is incorrect.

- I. If you are installing your SIRIUS TTR1 Radio for the first time, continue with "Step 2: Enter Your SIRIUS Account Information" on page 23.

If you have previously entered your SIRIUS user name and key into the radio, and had tuned to a channel, the screen will show **Connecting**. When successfully connected, the **Buffering...** screen will be displayed as the channel information is streamed to the radio. When complete, you are returned to the main display screen and you should hear the audio playing. Otherwise, the **Category Tune** screen is displayed.

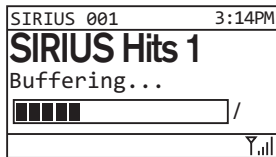
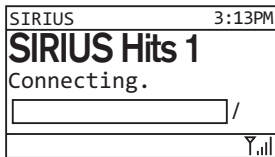

Connect to a Wired Network Using Manual Settings

In order to connect to a wired network, you will need to have the following information to enter during the procedure:

Is DHCP enabled or disabled?	
If disabled, the IP address to use for the radio?	
If disabled, the Subnet Mask IP address?	
If disabled, the Gateway IP address?	
If disabled, the Primary DNS IP address?	
If disabled, the Secondary DNS IP address?	

- a. At the rear of the radio, remove the compartment cover and connect an Ethernet cable to the Ethernet connector on the inside left of the compartment. Refer to “Wired Ethernet Connector” on page 11 for the location of the Ethernet connector. Replace the compartment cover.
- b. Connect the other end of the Ethernet cable to your home’s wired network.
- c. If you have just turned your SIRIUS TTR1 Radio on for the first time, the SSID screen will already be displayed. Skip ahead to step f.
- d. Press **MENU** and turn the **TUNE knob** to highlight **System Setup**. Press the **TUNE Knob**.
- e. Turn the **TUNE knob** to highlight **Network**. Press the **TUNE Knob**.
- f. Turn the **TUNE Knob** to highlight **Manual Settings [Manual config]**. Press the **TUNE Knob**.

Appendix: Manual Network Configuration

- g.** Turn the **TUNE Knob** to highlight **Wired**. Press the **TUNE Knob**.

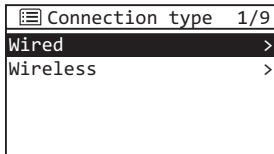

- h.** Will you be using DHCP? Turn the **TUNE Knob** to highlight **DHCP enable** or **DHCP disable** and press the **TUNE Knob**.
- i.** If you have selected **DHCP disable**, enter the following information. Otherwise, continue with step j.

For each entry, Turn the **TUNE knob** to select the numbers, and press the **TUNE knob** to confirm and move to the next number. Press **BACK** if you entered an incorrect number.



TIP! You can use the Remote Control to increment the numbers (\wedge \vee), and move forward or backward through the number fields ($+$ and $-$).

- Enter the IP address to use for the radio.
- Enter the Subnet Mask IP address for the network.
- Enter the Gateway IP address for the network.
- Enter the Primary DNS IP address for the network.
- Enter the Secondary DNS IP address for the network, or leave blank if there is none.

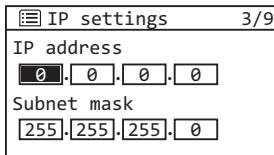

- j.** If you have entered the correct information, and the radio is able to connect to your network, the **Connected** screen will be displayed. If not, the **Failed to connect** screen is displayed. This means that one or

more of the settings you entered is incorrect. If **Waiting for Ethernet** is displayed, check the Ethernet cable connections.

- k.** If you are installing your SIRIUS TTR1 Radio for the first time, continue with “Step 2: Enter Your SIRIUS Account Information” on page 23.

If you have previously entered your SIRIUS user name and key into the radio, and had tuned to a channel, the screen will show **Connecting**. When successfully connected, the **Buffering...** screen will be displayed as the channel information is streamed to the radio. When complete, you are returned to the main display screen and you should hear the audio playing. Otherwise, the **Category Tune** screen is displayed.

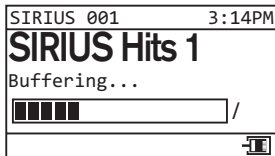
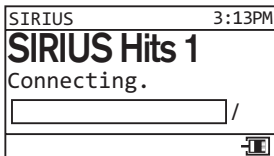
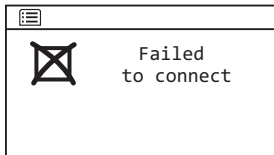
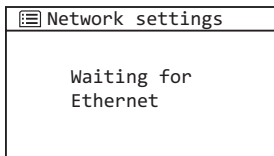
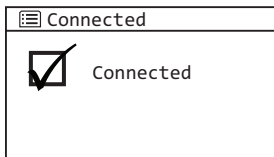

Troubleshooting

Troubleshooting

Your SIRIUS TTR1 Radio has been designed and built to be trouble-free but if you experience a problem, here's some troubleshooting hints.

You can also call SIRIUS Customer Care at 800-869-5964.

If you see this on the screen:	Try this:
Connecting	<ul style="list-style-type: none">• The radio is attempting to connect to the SIRIUS Internet Radio service. If this message is displayed more than one minute, make sure your network is connected to the Internet. To verify that you have an Internet connection, refer to "To force the radio to check for a software update:" on page 62 and follow the procedure. If you get the message Software up to date, or New version available, then the radio is connected to the Internet. If you get the message, Login failed, then you don't have an Internet connection. Check with your network administrator for Internet connectivity on your network.• Turn your radio Off and On again.
Buffering	<ul style="list-style-type: none">• The radio is loading the channel information. If this message is displayed for more than one minute, make sure your connection to the Internet has not been interrupted. See Connecting (previous troubleshooting item) and verify your Internet connection.• Turn your radio Off and On again.
Updating	<ul style="list-style-type: none">• Your radio is installing a software update. Do not turn the radio off. Allow the software update complete.

If you see this on the screen:	Try this:
Waiting for Ethernet	<ul style="list-style-type: none"> • The radio is expecting a wired Ethernet connection. Plug an Ethernet wire into your home network, then plug the other end into the Ethernet connection inside the compartment at the rear of the radio. (Refer to page 11 for the location of the connector.) • Change to a wireless network connection if a wired Ethernet connection is not available.
Login failed	<ul style="list-style-type: none"> • Your SIRIUS user name and/or password is incorrect, you don't have a subscription to the Premium SIRIUS Internet Radio service, or your subscription is no longer valid. To verify that you are subscribed to service, go to www.sirius.com, click on the LISTEN ONLINE link, and then click the LAUNCH PLAYER link. Enter your username and password. Select a channel to listen to and then click on the PREMIUM link. If you can listen in the Premium mode, then you are subscribed to the Premium SIRIUS Internet Radio service. Close the browser window to exit the player before continuing. <p>If you don't have a Premium SIRIUS Internet Radio subscription, go to www.sirius.com/siriusinternetradio or call 888-539-7474 to subscribe and get your user name and password. You can add this service to your SIRIUS subscription, or subscribe only to the Premium SIRIUS Internet Radio service.</p>

Troubleshooting

If you see this on the screen:	Try this:
Failed to connect	<ul style="list-style-type: none">• The network information you entered is incorrect. Verify and re-enter the information. (Refer to page 17 for a wireless network, or page 21 for a wired network.)• You have entered an incorrect password for a secure wireless network. Verify and re-enter the information. (Refer to page 23.)• If you have manually configured a network connection, you have entered one or more incorrect settings. Verify and re-enter the information. (Refer to page 66 for a wireless network, or page 71 for a wired network.)
Stream Closed	<ul style="list-style-type: none">• Your account username and password has been used at another location to connect to the Premium SIRIUS Internet Radio service, and your radio has been disconnected from the service. Turn your radio Off and On again.• The radio may have timed out due to lack of activity. Turn your radio Off and On again. To prevent a time-out, periodically adjust the volume, change the channel, or enter a menu, etc.
If this happens:	Try this:
You do not receive the same SIRIUS channels you receive on your Satellite Radio	<ul style="list-style-type: none">• The SIRIUS Internet Radio service does not have all of the same channels as the SIRIUS satellite service. Check www.sirius.com/siriusinternetradio and click the View Channel Lineup link for the latest channel lineup.

If this happens:	Try this:
The Network Wizard fails before the radio connects to your network	<ul style="list-style-type: none">• Your network has DHCP disabled. You'll have to manually configure your network connection. (Refer to page 66 for a wireless network, or page 71 for a wired network.)
The Network Wizard does not find your wireless network	<ul style="list-style-type: none">• Your wireless network has a hidden name (SSID). If so, you will have to manually configure your wireless network connection (page 66), or use a wired network connection (page 21 or page 71).• The wireless signal from your access point is too low. Try moving the radio closer to your access point and see if the Network Wizard finds your wireless network.

Product Specifications

Product Specifications

Dimensions

SIRIUS TTR1 Radio	283 mm (W) x 185 mm (H) x 95 mm (D) 11 in (W) X 7.25 in (H) X 3.75 in (D)
Remote	52 mm (W) x 85 mm (H) x 5 mm (D) 2 in (W) x 3.3 in (H) x .25 in (D)

Weight

SIRIUS TTR1 Radio	2.85 kg (6.3 lbs)
-------------------	-------------------

Audio Outputs

Headphone	3.5 mm diameter mini stereo jack
Line Out	3.5 mm diameter mini stereo jack

Audio Input

Aux In	3.5 mm diameter mini stereo jack
--------	----------------------------------

Patent and Environmental Information

Patent Information

It is prohibited to, and you agree that you will not, copy, decompile, disassemble, reverse engineer, hack, manipulate, or otherwise access and/or make available any technology incorporated in this product. Furthermore, the AMBE® voice compression software included in this product is protected by intellectual property rights including patent rights, copyrights, and trade secrets of Digital Voice Systems, Inc. The software is licensed solely for use within this product. The music, talk, news, entertainment, data, and other content on the Services are protected by copyright and other intellectual property laws and all ownership rights remain with the respective content and data service providers. You are prohibited from any export of the content and/or data (or derivative thereof) except in compliance with applicable export laws, rules and regulations. The user of this or any other software contained in a SIRIUS | XM radio is explicitly prohibited from attempting to copy, decompile, reverse engineer, hack, manipulate or disassemble the object code, or in any other way convert the object code into human-readable form.

Environmental Information

Follow local guidelines for waste disposal when discarding packaging and electronic appliances.

Your radio is packaged with cardboard, polyethylene, etc., and does not contain any unnecessary materials.

FCC Statement

The user is cautioned that changes or modifications not expressly approved by SIRIUS XM Radio Inc. can void the user's authority to operate this device.

This device complies with Part 15 of the FCC Rules:

1. This device may not cause harmful interference.
2. This device must accept any interference received, including interference that may cause undesired operation.

NOTE: This equipment has been tested and found to comply with the limits for a Class B digital device, pursuant to Part 15 of the FCC Rules. These limits are designed to provide reasonable protection against harmful interference in a residential installation. This equipment generates, uses and can radiate radio frequency energy and, if not installed and used in accordance with the instructions, may cause harmful interference to radio communications. However, there is no guarantee that interference will not occur in a particular installation. If this equipment does cause harmful interference to radio or television reception, which can be determined by turning the equipment off and on, the user is encouraged to try to correct the interference by one or more of the following measures:

- To comply with FCC RF exposure compliance requirements, a separation distance of at least 20 cm must be maintained between the antenna of this device and all persons.
- This device must not be co-located or operating in conjunction with any other antenna or transmitter.

Copyrights and Trademarks

©2009 SIRIUS XM Radio Inc. SIRIUS, XM and all related marks and logos are trademarks of SIRIUS XM Radio Inc. and its subsidiaries. All other marks and logos are the property of their respective owners. All rights reserved. Hardware, subscription and activation fee required. Other fees and taxes will apply. Month-to-month subscriptions must be activated via telephone. Hardware and subscription sold separately. Subscription governed by SIRIUS Terms & Conditions available at sirius.com/serviceterms. Prices and programming are subject to change. **SIRIUS Radio U.S. service only available in the 48 contiguous United States and the District of Columbia.**

sirius.com

**SIRIUS XM Radio Inc.
1221 Avenue of the Americas
New York, NY 10020**

1.800.869.5364

© 2009 SIRIUS XM Radio Inc.

SIRIUS TTR1 Radio 090809a